



CLUB STATION
K6SON

Short Skip

The Newsletter of

Sonoma County Radio Amateurs, Inc.

P.O. Box 116, Santa Rosa, CA 95402-0116 707-538-2931

<http://www.sonomacountyradioamateurs.com>

Repeaters:

English Hill: 147.315+ 88.5 / 224.480- 88.5 /
441.375+ 88.5



REPEATER STATION
W6SON

Volume 44, Number 3

March 2019

Hams Gone Wild!

Bent-Needle Protection for an MFJ-949E Tuner

By: Fred AE6SF

Brian N6IIY had the intriguing idea of simultaneously sharing a single antenna between two radios with external tuners operating on separate HF bands. Darryl KI6MSP and I briefly tested this concept at the Sonoma County Fair, where I observed the SWR meter movements pegging wildly on my MFJ-949E tuner. Thus, I designed and added the following limiter circuit to preclude bent needles.

Figure 1 shows the cross-needle SWR meter. Figure 2 shows a portion of the existing circuit that powers the reflected-power meter movement. The forward-power circuit is similar. Each meter deflects full scale at approximately 218 uA, 179 mV for an internal resistance of approximately 800 ohm. Two 50 Kohm calibration POTs are wired as variable resistors in series with each movement, selected via a 300W/30W range switch.

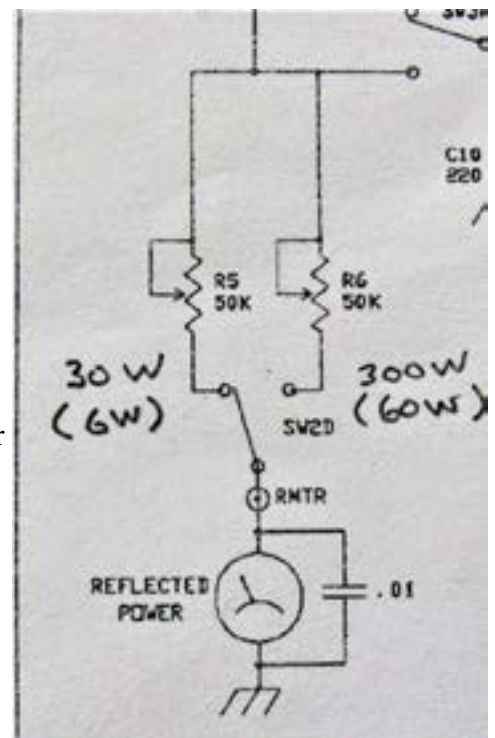

Figure 2
Existing
reflected-power
circuit



Figure 1
SWR meter

Experimentation indicated that each movement could withstand double the full-scale current and voltage without damage.

The limiter consists of a PN2222A NPN transistor that progressively shunts current to bypass the meter when the meter reaches and exceeds full scale voltage. Its schematic diagram is shown in Figure 3.



Continued on page 13...



VICE PRESIDENT'S MESSAGE MARCH



2019

Greetings club members. We are already rolling though 2019 with a year packed with activities. Our first public service (PS) event of the year is

the Fish Rock Bicycle Adventure event, staged from Boonville on March 9, 2019. Fourteen PS events are scheduled throughout the year, with details and sign-ups listed on the SCRA website. They are your chance to get involved with public service and have radio fun, so don't hesitate to sign up. If you are new to public service, sign up as a shadow. We'll pair you with an experienced ham and get you on the air. Bring your radio equipment to try out and discover why it does or doesn't work. Field testing really shows up the strengths and weakness of your radio equipment. I hope to hear you all on the air and see you in the field this year. (Digital modes are welcome, too.)

- Fred AE6SF, Vice President.



WellArd Loop Antenna

MARCH PROGRAM

A Novel 160M Loop Antenna!

by Jim WA6QBU

Calling all HF enthusiasts, including the HF curious who think the low bands like 160 meters are out of reach! This March at our membership meeting, we welcome Jim WA6QBU to present his new loop antenna that he developed for 160 meters. The antenna has been tested on the club's 160 meter Tuesday night nets on 1.910 MHz and has reached as far as southern California for QSO's. If you're interested in a compact and inexpensive magnetic loop design capable of fitting in anyone's backyard (or even on a balcony – after dark for hams subject to HOA) come check out Jim's talk for this month!

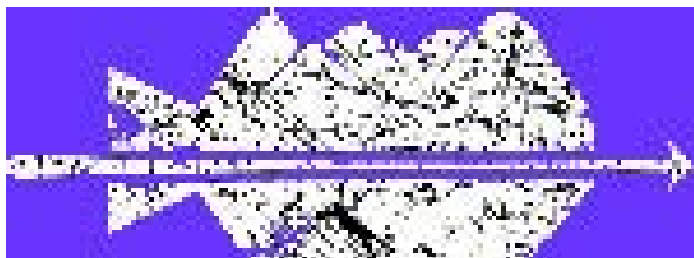

JOIN ARRL, THE AMERICAN RADIO RELAY LEAGUE

The ARRL is the national organization of Amateur Radio. It represents Amateur Radio at International Conferences and before the FCC. Get the monthly QST magazine, insurance for your equipment and too many other benefits to mention here. Click <http://www.arrl.org/membership/>



If you are not getting the ARRL San Francisco Section news by e-mail and you are an ARRL member, be sure to subscribe under your Members Only information or go to this Web site:

<http://www.arrl.org/Groups/view/san-francisco>



2019 Club Officers

President	John Felton	KE5RI
Vice President	Fred Seitel	AE6SF
Secretary	Bill Dornbush	KM6BYD
Treasurer	Iola Beckley	KK6HRE
Director	Fred Seitel	AE6SF
	Matias Santani	KM6GWK
Past President	Iola Beckley	KK6HRE

Committee Lineup/Contacts

Activities Programs	Jeff Tonelli, KI6PBF	jeff.tonelli@gmx.com
Community Outreach	Randy Hall AA6RH	aa6rh@socorad.io
DX/Contesting	Darryl Paule, KI6MSP	ki6msp@arrl.net
	Doug Payne, KF6LMB	dougpayne1@earthlink.net
Education	Cornell Chesnik, W6HMN	w6hmn@sonic.net
Emergency Services Liason	Pat Coyle, KG6JSL	coylaw@sonic.net
Field Day	Brian Torr, N6IYY	n6iyy@arrl.net
License Trustee	John Felton, KE5RI	jrfke5ri@aol.com
Website Manager	David Kraybill, KI6UGB	shortskipeditor@gmail.com
Membership	Dan Drummond, KK6VIQ	danjdrummond@hotmail.com
Merchandise	Dan Drummond, KK6VIQ	danjdrummond@hotmail.com
Public Service Coordinator	Iola Beckley, KK6HRE	iolabeckley104@gmail.com
Refreshments	Open	
Repeater	Jack Christensen, K6ROW	K6ROW@sonic.net
Roster Editor	Bill Dornbush, KM6BYD	bill@dornbush.net
Volunteer Examiners	Brian Torr, N6IYY	n6iyy@arrl.net
Weekly Email Blog	Pat Coyle, KG6JSL	coylaw@sonic.net

Short Skip & Web Staff

Short Skip Editor	David Kraybill, KI6UGB	shortskipeditor@gmail.com
Website Manager	David Kraybill, KI6UGB	shortskipeditor@gmail.com
Web Staff	David Pearson, K6DBP	grecojava@gmail.com

SCRA E-Mail	K6SON@arrl.com
SCRA Web site	http://www.sonomacountyradioamateurs.com

Short Skip Advertising Rates

Business Cards	\$12 per month
1st Quarter Column	\$13 per month
Each Additional Quarter Column	\$4 per month
Full page (one side)	\$35 per month
Pre-printed inserts (each)	\$35 per month

Short Skip is published monthly and copyright 2015 by the Sonoma County Radio Amateurs, Inc. Permission to reprint articles is granted provided the source is properly credited. Items printed do not necessarily represent the views of the SCRA or its editors. Letters, photos and articles sent to Short Skip are subject to editing and may or may not be printed.



SCRA Club Meetings

The club normally meets the first Wednesday of each month, socially at 6:30 pm, program starting at 7:00 pm. Exceptions are holidays or other big events.

Meeting location:
Luther Burbank Art & Garden Center
2050 Yulupa Avenue
Santa Rosa, CA

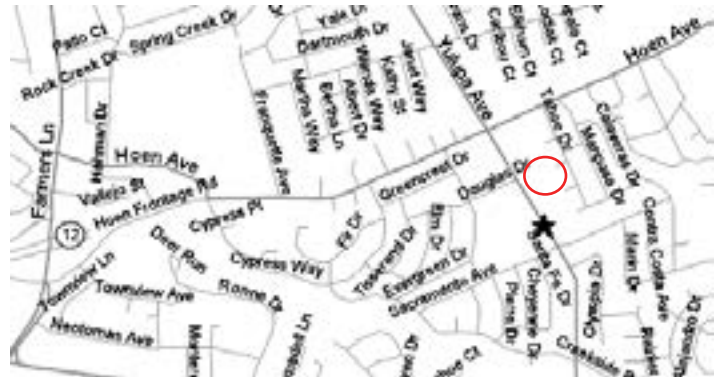

All are welcome!

Please join us at our next meeting. Anyone interested in Amateur Radio is eligible for membership. A membership application is included in this newsletter. For more information, contact any SCRA officer, director or member. Hungry before the meeting? Join us for dinner! We Meet at IHOP restaurant, 4th and Farmers Lane, Santa Rosa. People start showing up at 5:15 PM. No RSVP is required.

Board of Directors Meeting

The SCRA Board of Directors will meet monthly on the Second Wednesday at the IHOP Restaurant, Fourth Street, Santa Rosa (in the Safeway/CVS Pharmacy center). All members are welcome to attend, no reservations necessary. Arrive around 5:15- 5:30pm for dinner. Meeting starts at 6:00pm.

LOANER RADIOS AVAILABLE

The Club has a variety of radios available to members to try out and improve their skills. We have a Kenwood T590 SG HF radio; Yeasu FT 2900 2 meter mobile; Yeasu FT1D, an analog/digital 2 meter and 440mhz HT; Yeasu FT 60, a 2 meter and 440 mhz HT; and a TYT TH-F5 VHF 2 meter HT. Trying these out is an excellent way to learn some radio and test before you buy. Contact Joe, K6AWA, at k6awa@yahoo.com with your request. Joe will forward an information form to you by return email.

UPGRADE TO GENERAL OR AMATEUR EXTRA CLASS

Get more privileges and enjoyment from your Ham Radio Hobby. [Mentoring assistance](#) is available. Contact Cornell Chesnik, W6HMN, SCRA Education Chair, at w6hmn@sonic.net.

Tuesday Night Net

The Sonoma County Radio Amateurs' net meets Tuesday at 7:00 PM on the SCRA repeater, 147.315, positive offset, PL 88.5.

All members and guests are invited to check in. The Net includes updates on SCRA activities, and News-line, the amateur radio community news service.

Anyone wishing to work as net control should contact lola kk6hre, at K6SON@ARRL.NET for assignment. Script and logs are available on the Website at <http://sonomacountyradioamateurs.com/wp/resources/net-script/>



The Weekly 160 Meter Net

Announcing the new 160 meter net which runs from 8:45pm to 9:30pm Tuesday nights, immediately following the 10 meter net hosted by Joe K6AWA. Tune your radio frequency to 1.900 Mhz. LSB. 160 meters requires a General or above license to transmit.

Your New Tuesday Night Net Line-up

7:00pm Membership Net on the SCRA repeater, 147.315, positive offset, PL 88.5

10 Meter Net - starts at 8:00pm (new time) following the regular SCRA net Tuesday nights and ends at 8:45pm. Set your dial to 28,403.00 SSB, USB. Please note that all license classes (including technician) are welcome.

160 Meter Net - runs from 8:45pm to 9:30pm. Tune your radio frequency to 1.900 Mhz. LSB. 160 meters requires a General or above license to transmit.



Weekly SBARA Youth Net New Day and Time!

- For young people 18 and under
- Licensed youth or youth with a licensed control operator are welcome to check-in
- Check-in via EchoLink, if you are outside of the area
- Adults can check-in towards the end of the Net to answer questions and mentor the youth.

Please join our new, 13-year-old net control operator, Truman Lindsey, KM6AQS, and help us grow this important Net for young hams!

- SBARA Youth Net
- Every Tuesday evening, 6:30pm (1830), PACIFIC
- N6NFI repeater, Palo Alto, CA (145.230 MHz, -600 kHz, PL 100 Hz.)
- EchoLink Station: KR6DD-R

Steve Wilson KG6HJU
South Bay Amateur Radio Association
Fremont, CA
kg6hju@arrl.net

2019 SCHEDULE OF EVENTS

Check the [Club website](#) for details

Community outreach:

4/12 Family camping expo
5/4 Human Race
6/9 Monte Rio Vineman Triathlon
6/15 Kids Day
6/21-23 Field Day
8/4 Space Festival
8/3, 8/10 County Fair
9/28-29 PCAM
10/26 Science Festival

Public Service:

3/9 Fish Rock Road Adventure
4/6 SoNoMas bike
4/13 Lake Sonoma 50
4/28 2019 Wine Country Tour de Cure
5/4 Wine Country Century
6/9 Monte Rio Vineman Triathlon
6/15 Terrible Two
8/24 Tour de Fox
9/21-22 Waves to Wine
10/5 Gran Fondo
11/2 Sagan Fondo
11/9-10 Santa Rosa bike trione

80th Anniversary

4/? Skunk train
6/28 Field Day
8/25 or 8/11 Picnic
10/? Hamfest or swapmeet
12/4 Holiday dinner

OTHER:

8/15-18 Mini DX
10/19 JOTA
10/18-20 Pacificon
4/27 VOARC hamfest

VE Sessions

2/23
5/11
7/20
9/14
11/16

CONTEST CORNER

Welcome to Short Skip's Contest Corner for March 2019. This month I will begin listing any suitable contest for the following month that occurs before the newsletter becomes available. That way a person reading February's edition would have seen the ARRL International DX Contest, SSB on March 2nd. The cw ops just worked this contest in February so now the ssb folks have their time in March. All of the ARRL contests are worth mentioning as they welcome active participation from beginner to expert and offer excellent learning opportunities

One crucial element of amateur radio is the propagation of radio waves. Although there are amateur radio contests for VHF, UHF, etc., HF contests are what I will talk about here. HF propagation is one of those vast subjects that allow seemingly "magical" results when operating during a particular time. An introduction to HF propagation will help the beginner learn the whys and the why not of operating on the air. It is also a subject that all serious contesters must be familiar with before and during a particular contest in order to prepare fully and successfully log QSO's.

The sun of course is the prime mover here and just knowing what a solar cycle is will begin your introduction to HF propagation. Beyond that is a steep learning curve that does not end and the bottom line says "we are all still learning more about the sun and its properties". Daytime, nighttime, seasonal, yearly, sunspots, CME's, and so forth are just a few drivers of HF propagation. Try and learn what you can to assist and help you operating on the HF bands and any time spent contesting.

Other than the ARRL contest on March 2nd another SSB favorite is the CQ WW WPX Contest, SSB on March 30th. Oklahoma, Idaho, Wisconsin, Louisiana, and Virginia have their QSO Parties this month. I counted 17 or so sprints from the NCCC RTTY Sprint to the Feld Hell Sprint with various modes depending on the contest. Feld Hell you say? Other monthly favorites listed for March not mentioned.

Do not forget to check out <http://www.contestcalendar.com>

Contact nq6e@arrl.net for questions/comments/suggestions regarding Contest Corner.

72/73, NQ6E



Bruce Draper, AA5B, aa5b.corral@gmail.com

Contest Corral

March 2019

Check for updates and a downloadable PDF version online at www.arrrl.org/contests.

Refer to the contest websites for full rules, scoring information, operating periods or time limits, and log submission information.

Start - Finish Date-Time	Start Date-Time	Finish Date-Time	Bands	Contest Name	Mode	Exchange	Sponsor's Website
2 0000	3 2359	1.8-28	ARRL International DX Contest, SSB	Ph	W/VE: RS, SP, Non-W/VE: RS, power	www.arrrl.org/arrl-dx	
2 0000	10 2359	3.5, 7, 21, 28, 144	Novice Rig Roundup	CW	RST, QTH, name, class	novicrigroundup.com	
2 0600	2 0800	7-14	Wake-Up! QRP Sprint	CW	RST, serial, suffix of previous QSO	qrp.ru/contest/wakeup	
2 1800	3 1359	1.8-28	Open Ukraine RTTY Championship	Dig	2-letter region (state/province/canton), serial	krs.ho.ua/openrtty	
3 0700	3 1100	3.5	UBA Spring Contest, CW	CW	RST, serial, UBA section (if any)	www.uba.be/hf/contest-rules	
3 1200	3 1400	7	SARL Hamnet 40-Meter Simulated Emergency Contest	Ph	RS, serial	www.sarl.org.za	
3 1200	3 2200	3.5	NSARA Contest	CW Ph Dig	RS(T), county (if Nova Scotia)	nsara.ve1cfy.net/?page_id=82	
4 2000	4 2130	3.5	RSGB 80-Meter Club Championship, Data	Dig	RST, serial	www.rsgbcc.org/hf	
5 0200	5 0400	3.5-28	ARS Spartan Sprint	CW	RST, SPC, power	arsqrp.blogspot.com	
5 1900	5 2100	3.5	AGCW YL-CW Party	CW	RST, serial, name	agcw.org/index.php/en	
6 2000	6 2100	3.5	UKEICC 80-Meter Contest	Ph	4-char grid square	www.ukeicc.com	
7 1800	7 2200	28	NRAU 10-Meter Activity Contest	CW Ph Dig	RS(T), 6-char grid square	nrau.net/activity-contests	
7 2000	7 2200	1.8-28	SKCC Sprint Europe	CW	RST, SPC, name, mbr or power	www.skccgroup.com	
9 0000	9 2359	3.5-28	YB DX RTTY Contest	Dig	RST, serial	rtty.ybdxcontest.com	
9 1000	10 1000	50-1296	SARL VHF/UHF Analogue Contest	CW Ph	RS(T), 6-char grid	www.sarl.org.za	
9 1000	10 1000	3.5-28	RSGB Commonwealth Contest	CW	RST, serial	www.rsgbcc.org/hf	
9 1200	10 1200	3.5-144	F9AA Cup, SSB	Ph	RST, serial	www.site.urc.asso.fr	
9 1200	10 1200	28	South America 10 Meter Contest	CW Ph	RS(T), CQ zone	sa10m.com.ar	
9 1200	10 2359	1.8-50	SKCC Weekend Sprintathon	CW	RST, SPC, name, mbr or "none"	www.skccgroup.com	
9 1400	9 2000	3.5-28	AGCW QRP Contest	CW	RST, serial, class, mbr or "NM"	www.agcw.org	
9 1500	10 1500	1.8	Stew Perry Topband Challenge	CW	4-char grid square	www.kkn.net/stew	
9 1500	10 2100	3.5-50	Oklahoma QSO Party	CW Ph Dig	RS(T), county or SPC	k5cm.com/okqp.htm	
9 1600	10 1600	3.5-28	EA PSK63 Contest	Dig	RSQ, EA province code or serial	concursos.ure.es/en	
9 1800	10 0559	3.5	TESLA Memorial HF CW Contest	CW	RST, serial, 4-char grid	www.radiosport.org.rs	
9 1800	10 1800	1.8-50	QCWA QSO Party	CW Ph Dig	Year first licensed, name, SPC or chapter	www.qcwa.org	
9 1900	10 1900	1.8-28	Idaho QSO Party	CW Ph Dig	RS(T), county or SPC	idahoarri.info/qsoparty	
9 2200	9 2300	1.8-28	QRP ARCI Spring Thaw SSB Shootout	Ph	RS, SPC, mbr or power	www.qrparci.org/contests	
10 0000	10 0400	3.5-14	North American Sprint, RTTY	Dig	Other station's call, your call, serial, name, SPC	ncjweb.com	
10 0700	10 1100	144	UBA Spring Contest, 2 Meters	CW Ph	RS(T), serial, UBA section (if any)	www.uba.be/hf/contest-rules	
10 1800	10 2200	3.5	WAB 3.5 MHz Phone/CW	CW Ph	RS(T) serial, WAB square or country	wab.intermip.net	
10 1800	11 0100	All	Wisconsin QSO Party	CW Ph Dig	WI county or SPC	warac.org/wqp/wqp.htm	
11 0000	11 0200	1.8-28	4 States QRP Group Second Sunday Sprint	CW Ph	RS(T), SPC, mbr or power	www.4sqrp.com	
13 2000	13 2130	3.5	RSGB 80-Meter Club Championship, CW	CW	RST, serial	www.rsgbcc.org/hf	
13 2300	17 2300	7-14	AWA John Rollins Memorial DX Contest	CW	RST, equipment type and year	www.antiquewireless.org	
16 0200	18 0200	3.5-28	BARTG HF RTTY Contest	Dig	RST, serial, 4-digit UTC time	www.bartg.org.uk	
16 1200	17 1200	1.8-28	Russian DX Contest	CW Ph	RS(T), oblast or serial	www.rdxcc.org	
16 1400	16 1800	144, 432	AGCW VHF/UHF Contest	CW	RST, serial, class, 6-char grid	agcw.org/index.php/en	
16 1400	17 0200	1.8-144	Louisiana QSO Party	CW Ph Dig	RS(T), parish or SPC	laqp.louisianacontestclub.org	
16 1400	17 2359	All	Virginia QSO Party	CW Ph Dig	Serial, county or SPC	qsl.net/sterling/VA_QSO_Party	
16 2000	16 2159	1.8-28	Feld Hell Sprint	Dig	RST, mbr, SPC, grid	sites.google.com/site/feldhellclub	
17 0700	17 1100	3.5	UBA Spring Contest, SSB	Ph	RS, serial, UBA section (if any)	www.uba.be/hf/contest-rules	
18 0100	18 0300	1.8-28	Run for the Bacon QRP Contest	CW	RST, SPC, mbr or power	qrpcontest.com/pigrun	
18 1800	18 2059	3.5-7	Bucharest Contest	CW Ph Dig	RS(T), serial, county or country	yo3test201x.blogspot.ro/p/blog-page.html	
19 1700	24 1700	3.5-144	CLARA Chatter Party	CW Ph	RS(T), name, SPC	www.clarayl.ca	
21 0030	21 0230	3.5-14	NAQCC CW Sprint	CW	RST, SPC, mbr or power	naqcc.info	
23 0000	23 2359	1.8-VHF	FOC QSO Party	CW	RST, name, mbr (if any)	g4foc.org/qsoparty	
23 1200	24 1200	3.5-28	UKEI DX Contest, CW	CW	RST, serial, district (if UK/EI)	www.ukeicc.com	
24 0000	24 0400	3.5-14	North American SSB Sprint Contest	Ph	Other station's call, your call, serial, name, SPC	ssbsprint.com/rules	
24 0600	24 1000	50	UBA Spring Contest, 6 Meter	CW Ph	RS(T), serial, UBA section (if any)	www.uba.be/hf/contest-rules	
27 0000	27 0200	1.8-28	SKCC Sprint	CW	RST, SPC, name, mbr or power	www.skccgroup.com	
27 2000	27 2100	3.5	UKEICC 80-Meter Contest	CW	4-char grid square	www.ukeicc.com	
28 2000	28 2130	3.5	RSGB 80-Meter Club Championship, SSB	Ph	RS, serial	www.rsgbcc.org/hf	
30 0000	31 2359	1.8-28	CQ WW WPX Contest, SSB	Ph	RS, serial	www.cqwp.com	

All dates refer to UTC and may be different from calendar dates in North America. Contests are not conducted on the 60-, 30-, 17-, or 12-meter bands. Mbr = Membership number. Serial = Sequential number of the contact. SPC = State, Province, DXCC Entity. XE = Mexican state. Listings in blue indicate contests sponsored by ARRL or NCJ. The latest time to make a valid contest QSO is the minute listed in the "Finish Time" column. Data for Contest Corral is maintained on the WA7BNM Contest Calendar at www.contestcalendar.com and is extracted for publication in QST 2 months prior to the month of the contest. ARRL gratefully acknowledges the support of Bruce Horn, WA7BNM, in providing this service.



Digital Mobile Radio

SCRA DMR Updates

Sonoma County Talk Group 31707!

The club's DMR footprint continues to expand! We established a beachhead on DMR and the BrandMeister network of repeaters and hotspots by adding a talk group for Sonoma County! We are using talk group number 31707 to keep in touch on DMR and be able to discuss local news and topics of interest. The use of a talk group like 31707 allows a wider variety of Sonoma County DMR hams to be able to consistently reach each other on the air. Best of all, the 31707 talk group can be reached on hotspots as well as repeaters, meaning you can tie into your local community wherever you are!

Sonoma County DMR Net, Mondays at 6PM PT!

We also started a DMR net for Sonoma County (using talk group 31707) that lets us practice a little bit of traffic handling, while also allowing us to get together and talk about ways we can integrate DMR into our normal operating habits! Currently Randy AA6RH runs net control, and it's scheduled ahead of the "Sonoma County EmComm Net Crawl" on Monday evenings. If you have a DMR radio, make sure to program it (or ask Randy to help you program it) to include talk group 31707 on any of the area DMR repeaters (there are at least four in Sonoma County!) and join us on Monday evenings!

The Myth of Latency

Critics of DMR use the talking point that the latency and Internet-connectedness of DMR repeaters and hotspots make the mode unusable or less-than-optimal. Nothing could be further from the truth! When working a DMR station that is nearby (say, someone here in Sonoma County), the latency you encounter is nearly always under a few milliseconds. It's even less if you're both using the same repeater! It's only when doing "DMR DX" on talkgroups like Worldwide 91 that you have to exhibit a bit more patience to keep a QSO going. The rule of thumb that works pretty universally with DMR:

1. Tune your radio to your favorite repeater/hotspot frequency and talk group.
2. Hold the PTT for a moment (maybe one second, then release PTT) to connect the radio to the repeater, and let the repeater connect to the talk group on BrandMeister.
3. Wait a few moments (i.e. listen) to see if a QSO is in progress on the talk group. You may want to wait for at least five to ten seconds.
4. Key up, wait for a confirmation tone from your radio (which normally will chirp to let you know that you have connected).
5. Wait about one more second for the connection to BrandMeister to settle.
6. Begin your transmission.

Is it as "rapid-fire" as some 2-meter analog conversations? Of course not, this is communication, not a footrace! Good operating practice in general applies here just the same as in other modes on the air, and patience is one of them.

The best part about the mode is that there are literally thousands of hams on DMR, and they want to talk. So if you want to talk with interesting people, interested in the same things you are interested in (i.e. our shared hobby), why wouldn't you give it a try? Make sure to contact Joe K6AWA to check out one of the DMR HT's the club has in the Radio Loaner Program, and see for yourself!

Repeater Down or Far Away? Get a Hotspot!

The club is still exercising and testing its DMR repeater. Sometimes that means it will be offline and unavailable for use. As we get the repeater into a more "carrier-class" service level, DMR (and really any digital voice mode) enthusiast can scratch their DMR itch by getting a hotspot! We'll tackle this topic in more detail in a future program for the membership meeting, but there are several devices out there in the marketplace that allow you to leverage your own Internet broadband connection to make your own personal DMR "repeater".

The advantages are numerous, including (but not limited to):

Connect to a talk group and listen to it all day long (if you want) without the 15-minute timer that most repeaters have

Continued on page 8...



...DMR continued from page 7

Roam to areas where there are no DMR repeaters (but there is 3G or 4G mobile phone coverage), share your mobile phone's data connection, and connect your hotspot

Travel to the four corners of the globe, connect to a wifi access point, and talk to the people in your home location, with sound quality like they were sitting next to you.

That's just scratching the surface of these handy devices. SharkRF makes one of the easiest and more popular hotspots (the OpenSpot2) and there are countless homebrew "MMDVM" hotspots available on eBay or Amazon. Randy AA6RH is looking to build several of these homebrew hotspots if there is enough interest. Let him know if you want one!

Upcoming Plans for DMR

There is a lot more coming up with DMR in Sonoma County. The possibility of linking the analog club repeater to the DMR 31707 talk group for the weekly club net is one of many projects being considered. Several clubs in California and across the nation have implemented these bridges, meaning that the trail has been blazed and all we need to do is follow it! Are you excited about DMR? You should be, as it is available right now in Sonoma County, it doesn't cost a lot to get started with it, and help is available to get you on the air using this digital voice mode!

SCRA Membership Report

The renew season has come to an end. One more thanks to all our members for renewing their support in 2019!

The SCRA membership stands at 189.



Welcome new and returning members:

- James Hayes KK6HZS (T) Rohnert Park
- Dale Jenkins KM6UAD (T) Guerneville
- Marilyn Fox KM6RQA (T) Guerneville
- Tom Sawyer K6BX (E) Santa Rosa
- Ray Beauchesne KC6NEW (G) Sebastopol
- Nicholas Beloberk KJ6LDN (T) Santa Rosa
- John Fouts KM6LI (A) Calistoga



New call signs:

- Warren Pierce - K6WRP



License Class Upgrades:

- none reported

If you have recently achieved a new license class, obtained a new call sign, or changed your address, email or phone, please email membership@sonomacountyradioamateurs.com with your update. And don't forget to report your address change to the FCC!

TELEGRAPHY

"Samuel Morse must have lost his mind if he believes in this idea himself."
-Senator Oliver Hampton Smith. (1842)



**Sonoma County Radio Amateurs
Membership Meeting Minutes
Date: February 6, 2019, 7:03 PM**

Announcement: Darryl Paule KI6MSP announced that Charles Christiansen W6CLC passed away January 29 and is now a Silent Key. The memorial is at Franklin Park Feb 16 11:00. See his obituary in the PD.

Board members present: John Felton KE5RI, Fred Seitel AE6SF, Iola Beckley KK6HRE, Randy Hall AA6RH, Bill Dornbush KM6BYD
Absent: Matias Santani KM6GWK

Call to order: The president determined that a quorum is present.

New members: Marilyn Fox KM6RQA; Dale Jenkins KM6UAD; Tom Sawyer K6BX; Ken Florek N4NTJ; Ray KC6NEW

Guests: none present

NET CONTROL: The following members are the net control stations for February

Feb 12: Fred AE6SF
Feb 19: Darryl KI6MSP
Feb 26: Brian N6IYY
Mar 5: Iola KK6HRE

Announcements etc:

Doug Payne KF6LMB needed some help, John KE5RI found the fuse problem, they got on the air and talked to Japan.

Iola KK6HRE has someone who needs help installing a tower and antenna.

Joe K6AWA: on the 10 meter net, we contacted Fred in Quartzite, Arizona, and also at Winter Field Day
John: Thanks to Joe for opening his home for WFD

Mike AD6YB: Rex Morgan in the comics are about to crash an airplane next to a ham shack. He thought you might want to view the comics story as he expects the ham to be the hero.

Scott KJ6QYQ has relocated to Santa Rosa after the fire.

Darryl KI6MSP helped Brookhaven School with ARISS contact. He has expanded to the Sonoma County Library to repeat an ARISS contact.

Randy AA6RH: we have a DMR repeater club on the air again at English Hill. We are launching a talk group 31707 that works with repeaters and hotspots.

Dan KK6VIQ: Merchandise is trying something new. He showed the 80th anniversary logo, polo shirts with 80th logo. Halls will set up website for us to order, you can choose different colors and size, they will deliver later in a few months.

Program: John Prouty AG6PN of Bike Monkey Events and Event Communications. John presented the event planning including communications planning and the need for amateur radio real time communications for rider and volunteer safety and comfort. 50 people attended the presentation.

BREAK

Approval of minutes: As published in Short Skip, Charlie KZ6T made a motion to approve, Doug KF6LMB seconded and the motion was approved by voice vote.

REPORTS

Treasurer report: Iola KK6HRE presented the January 1 and January 31 balances. She will check income and expenses for January as presented.

Activities: Iola KK6HRE: Events are 80th anniversary ones, next is the Skunk Train trip.

Community outreach: Darryl KI6MSP: no report
Education: Cornell W6HMN: The next class is Mar 22-24 at National Instruments on Stony Point Rd, 7 people interested

Continued on page 10...

...Minutes continued from page 9

Winter Field Day: Brian N6IYY: We had wonderful weather, transportation was a challenge, antennas and stations were set up Friday, Saturday at 11 am we started, and results were more pleasing than expected: 133 CW contacts, 178 phone, 44 digital, multiplier for bands and modes 9, power multiplier 2, total points 4788*2, 4500 bonus points, 3000 for not at home, 1500 for not on the grid, 1500 Nick N1CKA made a satellite contact, we had fun launching the antenna. We should have 14076 points which would make us 6 of 94 last year. 4 more contacts would be an additional 4360 points, a goal for next year.

Merchandise: Dan KK6VIQ: nothing additional

Membership: Dan KK6VIQ: We have 184 members after 3 new and 3 renewed tonight.

Repeater: Jack K6ROW: The DMR repeater information is on the club website, and is in place of UHF radio which is temporarily not installed.

DX Team: Doug KF6LMB: It will be in Humboldt County Aug 15-17, the same time as the North American QSO party.

VE testing: Brian N6IYY: The next testing will be Saturday, March 2 at the Bennett Valley Grange Hall, cost is \$15.

Public Service: Iola KK6HRE: The first event will be March 9, Fish Rock Road Adventure, with Fred AE6SF as comm boss. We need 3 more people signed up for this event.

3 events in April are pretty well set for comm bosses, Fred AE6SF, Eric AA6EM, Darryl KI6MSP, and we need more help for the rest of the year.

Refreshment committee: no report

Radio loaner program: Joe K6AWA requested that the program report be moved to the announcements section at the beginning of the meeting so all who attended the meeting could hear about this program. An FT 991 is available tonight, and the new Vertical Zero5 antenna performed adequately according to

Charlie KZ6T.

Budget: Iola KK6HRE reviewed the proposed budget. After discussion, Darryl KI6MSP moved that the budget increase by \$100 for mini-dx, Doug KF6LMB seconded the motion and it was approved by voice vote.

NEW BUSINESS

Joe K6AWA noted that Nick N1CKA made brass plaques for us.

Dave KI6UGB presented the ham of the month award to Fred AE6SF for reporting in Short Skip and organization of events.

The meeting adjourned at 9:21 pm.

Respectfully Submitted,
Bill Dornbush KM6BYD



Ham of the Month
Fred Seitel AE6SF

SCRA HAM OF THE MONTH RECIPIENTS			
Year	Month	Name	Call Sign
2019	Feb	Fred	AE6SF
2019	Jan	Dave	KI6UGB
2018	Dec	none	
2018	Nov	Iola	KK6HRE
2018	Oct	Dan	KK6VIQ



SCRA BOARD OF DIRECTORS MEETING MINUTES

Date: February 13, 2019

Call to order by John Felton KE5RI at 6:00 pm. A quorum was present.

Board members present: John Felton KE5RI, Fred Seitel AE6SF, Bill Dornbush KM6BYD, Iola Beckley KK6HRE, Randy Hall AA6RH

Absent:, Matias Santani KM6GWK

Others: Doug Payne KF6LMB, Cornell Chesnik W6HMN, Pat Coyle KG6JSL, Joe Fortuna K6AWA, Charlie Sikes KZ6T, Brian Torr N6IIY, Darryl Paule KI6MSP, Dan Drummond KK6VIQ

Approval of previous meeting minutes: Fred AE6SF moved they be approved as submitted, and Iola KK6HRE seconded. Motion was approved.

OFFICER AND DIRECTOR REPORTS

Treasurer report: Iola KK6HRE. Discussion of treasurer report submitted at the 2/6/19 membership meeting. Iola will send a full report for February.

COMMITTEE REPORTS

Activities – Brian N6IIY is working on skunk train arrangements. He looked at their website about the North spur to Willits, cost about \$75 per person at group rates. He will contact the “chief skunk” and visit to see the train cars. Questions what are accommodations, what time would we have to set up, what dates are possible. There was a question if we can be ready for an April trip.

Iola presented some information on the October Ham Fest and Pasta Feed. We discussed possibilities of how to do it. Joe K6AWA suggested we consider a picnic at Night of Nights.

Community Outreach – Darryl KI6MSP is working on an article for AR newslines on 80th anniversary. He got Sonoma County Library accepted for an ARISS contact later this year.

Membership – Dan KK6VIQ said membership

renewal period is over. We have 35 members who did not renew. 105 of 180 members also belong to ARRL. He felt we need to update membership application form.

Public Service – Iola KK6HRE is still working on comm bosses for this year public service events.

Merchandise – Dan KK6VIQ reported about the shirt selling changes with Halls. He would like one price for any size shirt.

Education – Cornell W6HMN has 11 people interested in the next training event.

Em Comm – Pat KG6JSL has no report

Field Day – Brian N6IIY is going to Santa Rosa to sign up for the permit tomorrow. He is working with Piner Prospectors to see if we can use their field as an alternate.

Programs – Randy AA6RH is planning for Jim WA6QBU to talk about 160M loop antenna for the March program. He is still open for April and is looking at a program on comm bossing. May is Joe K6AWA talking about HF with a demonstration. June is Field Day. Darryl asked about a program on propagation and suggested Keith AG6CI.

Website – Dave KI6UGB is not present

Refreshments – Iola KK6HRE is working with Cornell W6HMN

Repeater – Charlie KZ6T reported that Jack K6ROW announced we are switching to UHF DMR at English Hill, meaning we no longer have a UHF repeater in service. We discussed the possibility of reinstalling UHF at Castle Rock.

Radio Loanout program – Joe K6AWA has all the DMR equipment out on loan. He has a lot of HF equipment to loan.

Unfinished Business – none

NEW BUSINESS - none
Meeting ended at 7:00 pm

SCRA Merchandise Report

The Sonoma County Radio Amateurs are pleased to announce our 2019 80th Anniversary Apparel Event!

This event will be accessed through a website created by Halls Executive Gifts and Awards of Rohnert Park. As this Short Skip goes to publication, there's still a few details that need to be worked out. As soon as we are ready to accept orders, an email will be sent out to membership with the website link and more specific information.

When we do go live, you'll have a number of weeks to order from a selection of shirt styles for men and women. Once we reach the minimum order point, set by Halls, an email will be sent to membership specifying the end date of this event. After the end date, the shirts will go into production and purchasers will be notified when their orders are ready for distribution.

T-Shirts, short and long sleeve, will be priced at \$16 each and Polo shirts at \$21 each. Depending on the style you choose, you'll find a large array of colors and sizes, XSmall to 6XLarge.

The T-Shirts feature our 80th Anniversary logo design printed onto a 100% cotton fabric. The Polo shirts feature an 80th Anniversary text, with our Mic-&-Key logo, embroidered onto a 60/40 cotton/poly pique fabric. More specific product descriptions will be found near the bottom of each product page. The Merchandise Committee thanks you for your patience on this upcoming first-time product event where you get to choose the style, color and size that fits you best.

An update will be given at the Wednesday, March 6th membership meeting.



...Bent Needle Protection continued from page 1

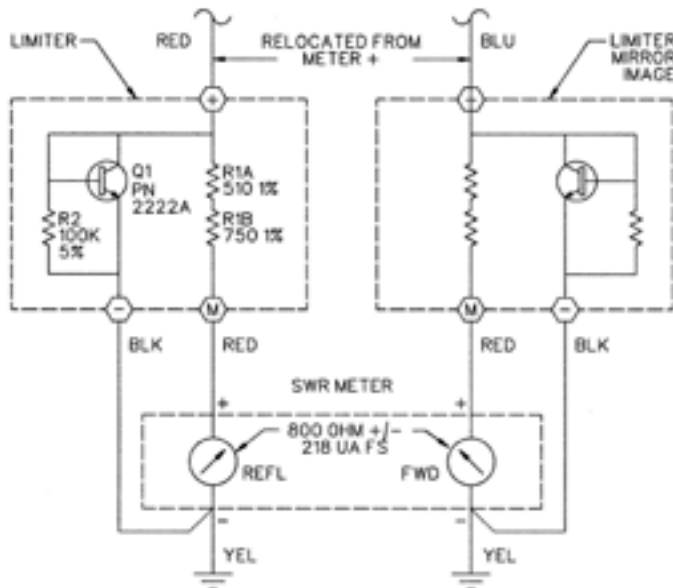

Figure 3. Limiter schematic diagram.

With the meter at 175% voltage, the limiter bypasses more than 100 mA, or roughly 500 times the meter's full-scale current. The current-voltage profile is shown in Figure 4.

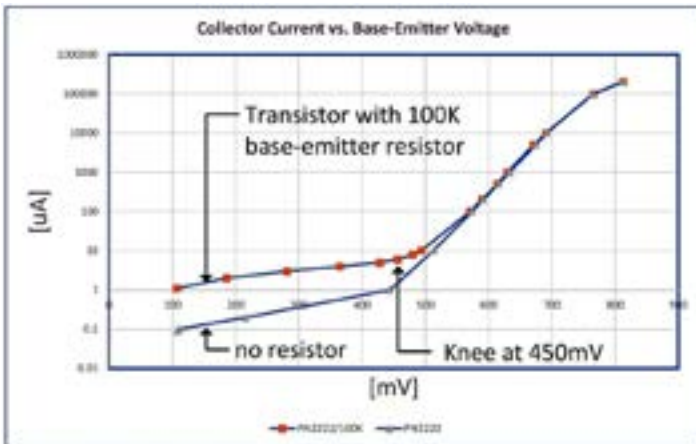

Figure 4. Current-voltage profile.

A 100 Kohm base-emitter resistor was added to ensure the transistor remained off below the 450 mV knee shown on the current-voltage profile. Below full-scale voltage, the resistor dominates, and its linear load is tuned out through recalibration. Above full-scale voltage, the transistor dominates with an exponential characteristic. The knee voltage varies with ambient temperature, but the variation is insignificant for

normal usage.

A series resistance of 1260 ohm (510 + 750) was added ahead of the meter movement to provide the 450 mV drive for the transistor when the meter is at full scale. The calibration POTs were backed off accordingly.

Perf-board construction is suitable. Lay out one circuit as the mirror image of the other. Then the limiters will mount nicely to the terminals of the two movements. See Figures 5-7.



Figure 5. Two limiters on perf board before separation



Figure 6. Limiters installed on back of meter movements

Continued on page 14...

...Bent Needle Protection continued from page 13

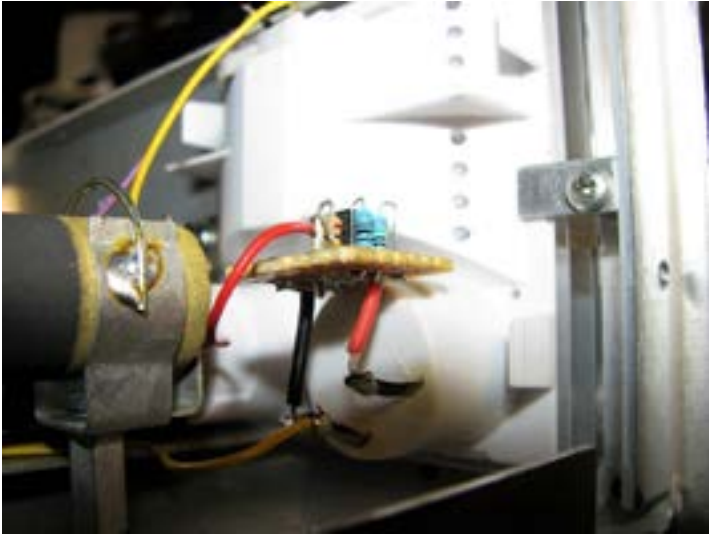
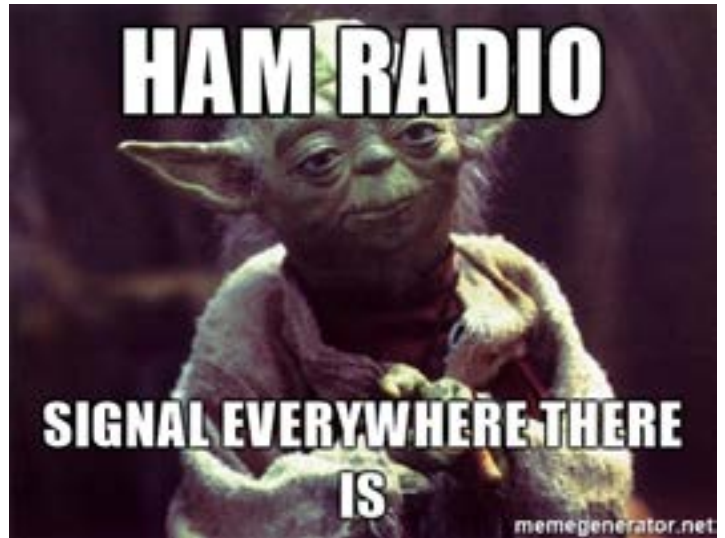

Figure 7. View showing wire connections.



**Ham Radio - Crazy antennas and QRP
 - The baseball diamond backstop
 (YouTube video, click photo to play)**





Sonoma County Radio Amateurs, Inc.
PO Box 116, Santa Rosa, CA 95402
(Please print this, fill it out, and send it in with your check.)

Name _____ Callsign _____ License Class _____
Mailing Address _____ Phone _____ Cell _____
City _____ Zip _____ New Application _____ Renewal _____
E-mail (if any) _____ Add to Roster (Yes)___ (No) ___

Please Send Short Skip & Roster to my E-mail address () YES! () No thanks

FAMILY MEMBERS, CALL SIGNS & EMAIL ADDRESSES:

1. Name _____ Callsign _____ License Class _____ Add to Roster (Yes)___ (No) ___
E-mail _____ Short Skip & Roster to my E-mail address () YES! () NO
2. Name _____ Callsign _____ License Class _____ Add to Roster (Yes)___ (No) ___
E-mail _____ Short Skip & Roster to my E-mail address () YES! () NO
3. Name _____ Callsign _____ License Class _____ Add to Roster (Yes)___ (No) ___
E-mail _____ Short Skip & Roster to my E-mail address () YES! () NO
4. Name _____ Callsign _____ License Class _____ Add to Roster (Yes)___ (No) ___
E-mail _____ Short Skip & Roster to my E-mail address () YES! () NO

SCRA Dues: The renewal date for SCRA dues is January 1st. Dues are \$20/year for individual, \$30/year for families, and \$15/year for youth (under 18).

PRO-RATED DUES for new members only: Reduce standard dues rate by \$5.00 per quarter. (ie. Second Quarter, April – June \$15.00; Third Quarter – July – September \$10.00; Fourth Quarter, October – December \$5.00 to end of December of current year or \$25.00 through December of the following year)

I WOULD LIKE MORE INFORMATION ABOUT:

() Public Service Events () Acting as club Net Control Station
() ARES Emergency Services () Helping with VEC license exams
() Taking a Novice or Technician class () Field day, other operating
() Teaching a Novice or Technician class () Helping with Short Skip Newsletter
() Taking an upgrade class () Other _____
() Teaching an upgrade class

SCRA DUES: Individual \$20, Family \$30, Youth, under 18, \$15 + _____
Name Badge (complete info below) \$10 each Circle: Magnet or Clip attachment + _____

Name Badge Information Fill in exactly as you want it to appear on your badge.
Callsign _____ First Name _____ City _____
Callsign _____ First Name _____ City _____
Callsign _____ First Name _____ City _____

SCRA Patch \$5/ea + _____
SCRA T-Shirt \$13./ea Size: s m l xl xxl + _____

Total: \$ _____

(Please make checks payable to SCRA. Send to SCRA, Box 116, Santa Rosa, 95402)



HAM RADIO OUTLET

WWW.HAMRADIO.COM

MULTI-STORE BUYING POWER!

ICOM®



IC-7600
All Mode Transceiver



IC-7200
HF Transceiver



IC-7100
All Mode Transceiver



ID-5100A Deluxe
VHF/UHF Dual Band Digital Transceiver



ID-51A Plus
VHF/UHF Dual Band Transceiver

KENWOOD



TS-590SG
HF/50MHz Transceiver



TM-D710G
2M/440 DualBand



TM-V71A
2M/440 DualBand



TM-281A
2 Mtr Mobile



TH-D74A
2M/220/440 HT

YAESU The radio



FT-991A
HF/VHF/UHF Transceiver



FTDX1200
100W HF + 6M Transceiver



FT-450D
100W HF + 6M Transceiver



FTM-400XD
2M/440 Mobile



FT-60R
2M/440 5W HT



- **RETAIL LOCATIONS** – Store hours 10:00AM - 5:30PM - Closed Sunday
- **PHONE** – Toll-free phone hours 9:30AM - 5:30PM
- **ONLINE** – WWW.HAMRADIO.COM
- **FAX** – All store locations
- **MAIL** – All store locations

HRO is family owned and operated by active hams!

ANAHEIM, CA
(800) 854-6046

OAKLAND, CA
(877) 892-1745

PORTLAND, OR
(800) 765-4267

PHOENIX, AZ
(800) 559-7388

MILWAUKEE, WI
(800) 558-0411

WOODBIDGE, VA
(800) 444-4799

PLANO, TX
(877) 455-8750

BURBANK, CA
(877) 892-1748

SAN DIEGO, CA
(877) 520-9623

DENVER, CO
(800) 444-9476

ATLANTA, GA
(800) 444-7927

NEW CASTLE, DE
(800) 644-4476

SALEM, NH
(800) 444-0047

ONLINE STORE
WWW.HAMRADIO.COM

*Except 60M Band. **Frequency coverage may vary. Refer to owner's manual for exact specs. **Optional UX-9100 required. QST March 2017. The Icom logo is a registered trademark of Icom Inc. Toll-free including Hawaii, Alaska and Canada. Call will be routed to the nearest store. All HRO 800-lines can assist you. If the first line you call is busy, you may call another. AZ, CA, CO, GA, TX, VA, WI residents add sales tax. Prices, specifications and descriptions subject to change without notice.

SHORT SKIP ARCHIVES AVAILABLE

Mike, AD6YB, has set up archives for past and present issues of Short Skip. They are available on the Website, log into Members Area, Short Skip, click on the first sentence. Mike has scanned in the old paper issues and it is really interesting to browse through them to see what those guys were doing. There are historical photos as well. An important record of our history and ham radio in general. Good Stuff.

[\(Click Me\)](#)

DIDN'T FIND WHAT YOU NEEDED?

If you are looking for something more on a topic or your topic of interest hasn't been covered lately, let us know. Something you'd like to see in Short Skip?

Contact the editor, shortskippeditor@gmail.com or for general questions and /or suggestions, k6son@arrl.net

SHORT SKIP NEEDS YOUR INPUT

SHORT SKIP ARTICLES WANTED

Dave, KI6UGB, our Short Skip editor is always looking for articles of interest. They can be technical, a good (or bad) experience that other members may learn from, hints or kinks that worked for you in solving a problem, or just about anything ham radio related. Send your contributions to Dave at shortskippeditor@gmail.com

